



सत्यमेव जयते

भारत सरकार
GOVERNMENT OF INDIA
पेटेंट कार्यालय
THE PATENT OFFICE

ORIGINAL

No. 115817

CERTIFICATE OF REGISTRATION OF DESIGN

Design No. 344871-001
Date 17/06/2021
Reciprocity Date*
Country

Certified that the design of which a copy is annexed hereto has been registered as of the number and date given above in class 23-01 in respect of the application of such design to COUPLER in the name of WARAD SHASHANK GADRE, 301, MEGH APARTMENT, PRABHAT ROAD LANE NO 9/3 ERANDHWANE, PUNE - 411004

in pursuance of and subject to the provisions of the Designs Act, 2000 and the Designs Rules, 2001.

Controller General of Patents, Designs and Trade Marks

*The reciprocity date (if any) which has been allowed and the name of the country.
Copyright in the design will subsist for ten years from the date of Registration, and may under the terms of the Act and Rules, be extended for a further period of five years.
This Certificate is not for use in legal proceedings or for obtaining registration abroad

DR. MOHAN DEWAN,
R.K.DEWAN & COMPANY, PODAR CHAMBERS,
S.A.BRELVI ROAD, FORT, MUMBAI-400001

Date of Issue 07/07/2022 15:34:31

INTELLECTUAL
PROPERTY INDIA
DESIGNS | TRADE MARKS
GEOGRAPHICAL INDICATIONS

NAME OF APPLICANT: WARAD SHASHANK GADRE

NO.OF SHEETS USED: 04
SHEET NO.: 01

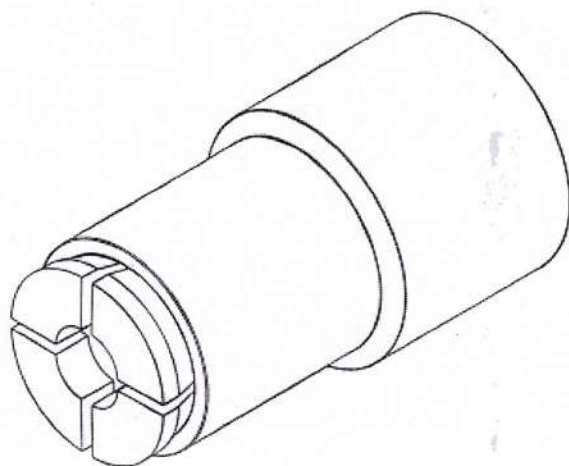

PERSPECTIVE VIEW

The novelty resides in the shape and configuration of COUPLER as illustrated:

No claim is made by virtue of this registration in respect of any mechanical or other action of mechanism or in respect of any mode or principle of construction of the article.

No claim is made by virtue of this registration in respect of the use of letters, numerals, trademark or words appearing in the said representation.

Dated this 16th day of June 2021

Dr. Mohan Dewan
OF R.K.DEWAN & COMPANY
Applicant's Attorney.

344871-001

7 JUN 2021

NAME OF APPLICANT: WARAD SHASHANK GADRE

NO.OF SHEETS USED: 04
SHEET NO.: 02

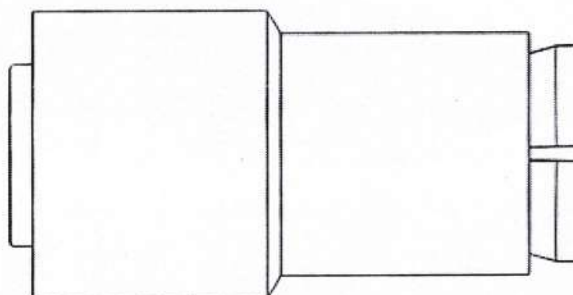

FRONT VIEW

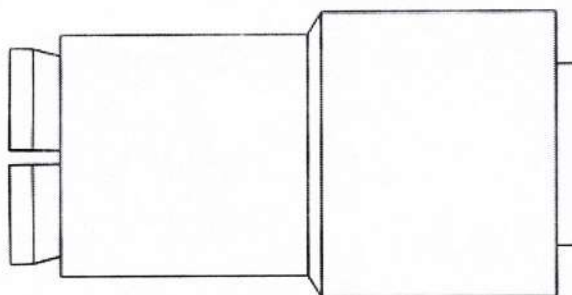

REAR VIEW

The novelty resides in the shape and configuration of COUPLER as illustrated:

No claim is made by virtue of this registration in respect of any mechanical or other action of mechanism or in respect of any mode or principle of construction of the article.

No claim is made by virtue of this registration in respect of the use of letters, numerals, trademark or words appearing in the said representation.

Dated this 16th day of June 2021

Dr. Mohan Dewan
OF R.K.DEWAN & COMPANY
Applicant's Attorney.

344871-501

7 JUN 2021

NAME OF APPLICANT: WARAD SHASHANK GADRE

NO.OF SHEETS USED: 04
SHEET NO.: 03

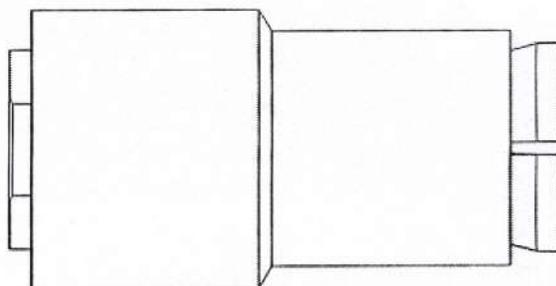

TOP VIEW

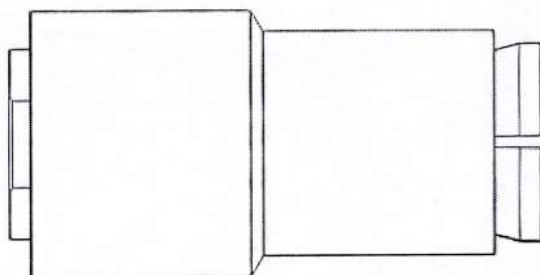

BOTTOM VIEW

The novelty resides in the shape and configuration of COUPLER as illustrated:

No claim is made by virtue of this registration in respect of any mechanical or other action of mechanism or in respect of any mode or principle of construction of the article.

No claim is made by virtue of this registration in respect of the use of letters, numerals, trademark or words appearing in the said representation.

Dated this 16th day of June 2021

Dr. Mohan Dewan
OF R.K.DEWAN & COMPANY
Applicant's Attorney.

344871-001

17 JUN 2021

NAME OF APPLICANT: WARAD SHASHANK GADRE

NO.OF SHEETS USED:04
SHEET NO.: 04

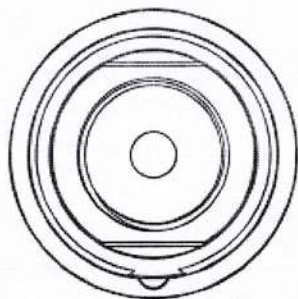

LEFT SIDE VIEW

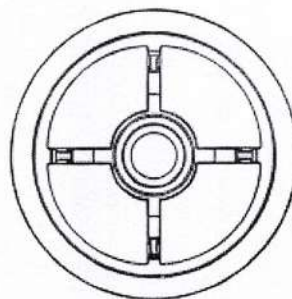

RIGHT SIDE VIEW

The novelty resides in the shape and configuration of COUPLER as illustrated:

No claim is made by virtue of this registration in respect of any mechanical or other action of mechanism or in respect of any mode or principle of construction of the article.

No claim is made by virtue of this registration in respect of the use of letters, numerals, trademark or words appearing in the said representation.

Dated this 16th day of June 2021

Dr. Mohan Dewan
OF R.K.DEWAN & COMPANY
Applicant's Attorney.

344871-001
17 JUN 2021